

C
A
T
A
L
O
G

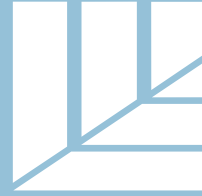

OMNI-TRACT® SURGICAL

Surgical Retractor Systems & Components

TABLE OF CONTENTS

Systems

PITTMAN IMA RETRACTOR SYSTEM • CS200	1
FASTSYSTEM® OMNI-RING RETRACTOR SYSTEM • GF500	1
FASTSYSTEM® GENERAL RETRACTOR SYSTEM • GF400	2
FASTSYSTEM® GENERAL EXPANDED RETRACTOR SYSTEM • GF450	2
FASTSYSTEM® PEDIATRIC RETRACTOR SYSTEM • PF100	3
FASTSYSTEM® PERINEAL PROSTATECTOMY RETRACTOR SYSTEM • UF100	3
FASTSYSTEM® UROLOGY RETRACTOR SYSTEM • UF400	4
FASTSYSTEM® EXPANDED UROLOGY RETRACTOR SYSTEM • UF450	4
FASTSYSTEM® STONEY PERIPHERAL VASCULAR RETRACTOR SYSTEM • VF100	5
FASTSYSTEM® VASCULAR RETRACTOR SYSTEM • VF400	5
FASTSYSTEM® EXPANDED VASCULAR RETRACTOR SYSTEM • VF450	6
FASTSYSTEM® UPPER ABDOMINAL RETRACTOR SYSTEM • BF200	6
OMNI-LAPOTRACT® LAPAROSCOPIC SCOPE & INSTRUMENT HOLDER	7
SPINE-TRACT® ANTERIOR LUMBAR RETRACTOR SYSTEM • AF400	7
SPINE-TRACT® ANTERIOR CERVICAL RETRACTOR SYSTEM • CF300	8
SPINE-TRACT® POSTERIOR LUMBAR RETRACTOR SYSTEM • LF400	8
ARTHRO-TRACT® SUPINE HIP RETRACTOR SYSTEM • HF500	9
ARTHRO-TRACT® LATERAL HIP RETRACTOR SYSTEM • HF600	9
ARTHRO-TRACT® SUPINE HIP RETRACTOR SYSTEM • HF800	10
ARTHRO-TRACT® LATERAL HIP RETRACTOR SYSTEM • HF900	10

Kits

OBESITY BLADE KIT • OK200	11
WISHBONE® EXTENSION ARM KIT • EK300	11
RADIOLUCENT ANTERIOR LUMBAR BLADE KIT • SK500	11

Components, Retractors, Blades & Pans12-20

Warranty & Company Information21

PITTMAN IMA RETRACTOR SYSTEM • CS200

Qty	Part#	Item
2	3630	Knob, Micro Adjust
1	3635	IMA Rail Clamp
1	3640	Post, Bent IMA
1	3647	T Post w/Clamp Assemblies, Adjustable

Choose one:

2	3259	Rake, IMA Micro Adjust, 16-3/8" (41.5cm)
2	3765	Rake, IMA Micro Adjust, Sharp Teeth, 16-3/8" (41.5cm)
2	3650	Rake, IMA Micro Adjust, Blunt Teeth, Squared 16-3/8" (41.5cm)

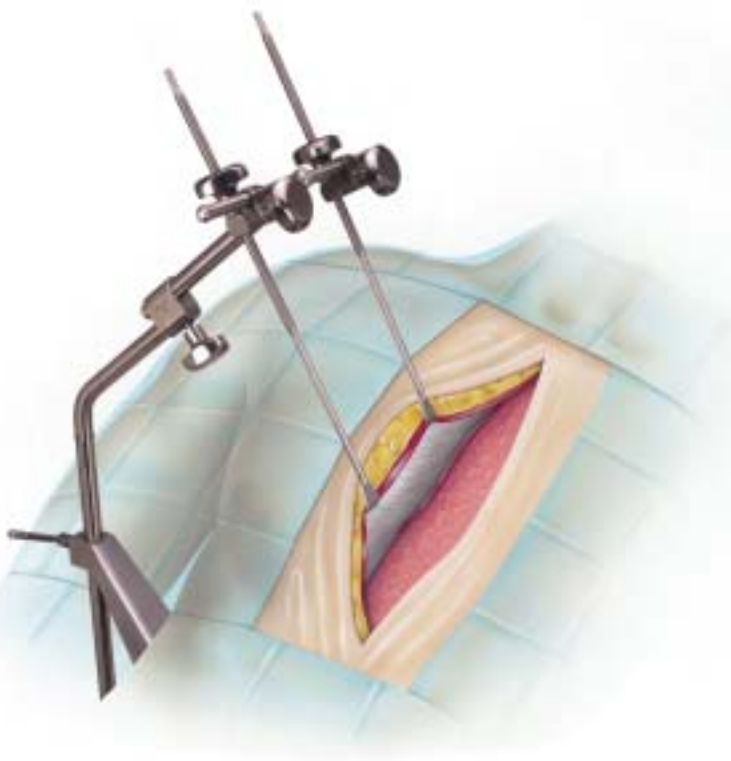

FASTSYSTEM® OMNI-RING RETRACTOR SYSTEM • GF500

Qty	Part#	Item
1	4080	Omni-Clamp Sterile Field Post
1	4090	Omni-Ring Oval 12" X 18", W/Arm (30.5cm X 45.7cm)
1	4070	Omni-Ring Round 12", W/Arm (30.5cm)
6	4040	SnapClamp
1	3911	Malleable Slotted Swivel Retractor, 1-1/2" X 6" (3.8cm X 15.2cm)
1	3788	Malleable Slotted Swivel Retractor, 2" X 6-1/2" (5cm X 16.5cm)
1	3790	Malleable Slotted Swivel Retractor, 3" X 6-1/2" (7.6cm X 16.5cm)
1	3794	Harrington Sweetheart Swivel Retractor, 2" X 5" (5cm X 12.7cm)
2	3866	Mayo Swivel Retractor, 2-3/4" X 3" (7cm X 7.6cm)
2	3906	Kelly Modified Swivel Retractor, 2" X 3" (5cm X 7.6cm)
1	3907	Kelly Modified Swivel Retractor, 2" X 4" (5cm X 10.2cm)
1	3908	Kelly Modified Swivel Retractor, 2" X 5" (5cm X 12.7cm)
1	3909	Kelly Modified Swivel Retractor, 2" X 6" (5cm X 15.2cm)

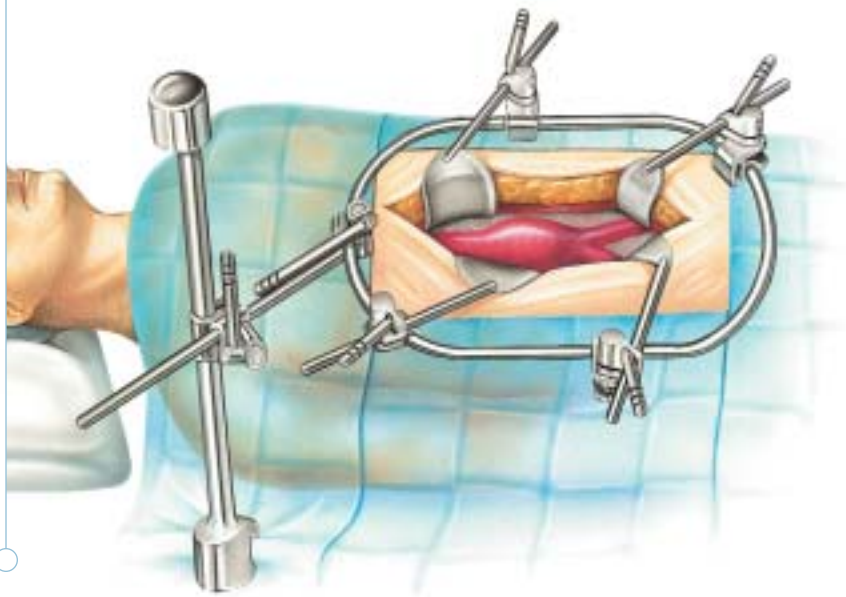

FASTSYSTEM® GENERAL RETRACTOR SYSTEM • GF400

Qty	Part#	Item
1	4080	Omni-Clamp Sterile Field Post
1	4020	FastSystem Standard WISHBONE
6	4040	SnapClamp
2	3335	Mayo Swivel Retractor, 2-3/4" X 2" (7cm X 5cm)
1	3772	Fence Swivel Retractor, 4" X 6" (10.2cm X 15.2cm)
1	3774	Splanchnic Swivel Retractor, 2" X 6" (5cm X 15.2cm)
1	3784	Deaver Swivel Retractor, 2-3/4" X 4-1/2" (7cm X 11.4cm)
1	3788	Malleable Slotted Swivel Retractor, 2" X 6-1/2" (5cm X 16.5cm)
1	3790	Malleable Slotted Swivel Retractor, 3" X 6-1/2" (7.6cm X 16.5cm)
1	3794	Harrington Sweetheart Swivel Retractor, 2" X 5" (5cm X 12.7cm)
1	3862	Kelly Modified Swivel Retractor, 3" X 2-1/2" (7.6cm X 6.4cm)
1	3864	Kelly Modified Swivel Retractor, 3" X 4" (7.6cm X 10.2cm)



FASTSYSTEM® GENERAL EXPANDED RETRACTOR SYSTEM • GF450

Qty	Part#	Item
1	4080	Omni-Clamp Sterile Field Post
1	4020	FastSystem Standard WISHBONE
8	4040	SnapClamp
1	3588	Extension Arm, Hinged
2	3335	Mayo Swivel Retractor, 2-3/4" X 2" (7cm X 5cm)
1	3772	Fence Swivel Retractor, 4" X 6" (10.2cm X 15.2cm)
1	3774	Splanchnic Swivel Retractor, 2" X 6" (5cm X 15.2cm)
1	3784	Deaver Swivel Retractor, 2-3/4" X 4-1/2" (7cm X 11.4cm)
1	3788	Malleable Slotted Swivel Retractor, 2" X 6-1/2" (5cm X 16.5cm)
1	3790	Malleable Slotted Swivel Retractor, 3" X 6-1/2" (7.6cm X 16.5cm)
1	3794	Harrington Sweetheart Swivel Retractor, 2" X 5" (5cm X 12.7cm)
1	3862	Kelly Modified Swivel Retractor, 3" X 2-1/2" (7.6cm X 6.4cm)
1	3864	Kelly Modified Swivel Retractor, 3" X 4" (7.6cm X 10.2cm)



NEW

FASTSYSTEM® PEDIATRIC RETRACTOR SYSTEM • PF100

Qty	Part#	Item
1	4080	Omni-Clamp Sterile Field Post
1	4985	FastSystem Small WISHBONE
6	4040	SnapClamp
1	4958	Rake Retractor, 7/8" X 1/2" (2.2cm X 1.3cm)
1	4957	Rake Retractor, 7/8" X 1" (2.2cm X 2.5cm)
2	4980	Mayo Swivel Retractor, 2" X 2" (5cm X 5cm)
2	4981	Mayo Swivel Retractor, 2-3/4" X 2" (7cm X 5cm)
1	4978	Mayo Swivel Retractor, 1" X 1" (2.5cm X 2.5cm)
1	4967	Malleable Swivel Retractor, 1" X 1" (2.5cm X 2.5cm)
1	4963	Malleable Swivel Retractor, 1/2" X 1" (1.3cm X 2.5cm)
2	4979	Mayo Swivel Retractor, 2" X 1-1/2" (5cm X 3.8cm)
1	4964	Malleable Swivel Retractor, 3/4" X 2" (1.9cm X 5cm)
1	4965	Malleable Swivel Retractor, 3/4" X 3" (1.9cm X 7.6cm)
1	4968	Malleable Swivel Retractor, 1" X 4" (2.5cm X 10.2cm)
1	4969	Malleable Swivel Retractor, 1" X 5" (2.5cm X 12.7cm)
1	4970	Malleable Swivel Retractor, 1" X 6" (2.5cm X 15.2cm)
1	4971	Malleable Swivel Retractor, 1-1/2" X 3" (3.8cm X 7.6cm)
1	4972	Malleable Swivel Retractor, 1-1/2" X 4" (3.8cm X 10.2cm)
1	4973	Malleable Swivel Retractor, 1-1/2" X 5" (3.8cm X 12.7cm)
1	4974	Malleable Swivel Retractor, 1-1/2" X 6" (3.8cm X 15.2cm)
2	4962	Splanchnic Swivel Retractor, 1-1/2" X 3-1/2" (3.8cm X 8.9cm)



NEW

FASTSYSTEM® PERINEAL PROSTATECTOMY RETRACTOR SYSTEM • UF100

Qty	Part#	Item
1	4080	Omni-Clamp Sterile Field Post
1	4985	FastSystem Small WISHBONE
5	4040	SnapClamp
1	4988	Perineal Extension Arm 20" (51cm)
4	4964	Malleable Swivel Retractor, 3/4" X 2" (1.9cm X 5cm)
4	4965	Malleable Swivel Retractor, 3/4" X 3" (1.9cm X 7.6cm)
4	4966	Malleable Swivel Retractor, 3/4" X 4" (1.9cm X 10.2cm)
1	4975	Posterior Swivel Retractor, 1-3/4" X 3" (4.5cm X 7.6cm)
1	4976	Posterior Swivel Retractor, 1-3/4" X 4" (4.5cm X 10.2cm)
1	4977	Anterior Swivel Retractor, 1-1/2" X 3" (3.8cm X 7.6cm)

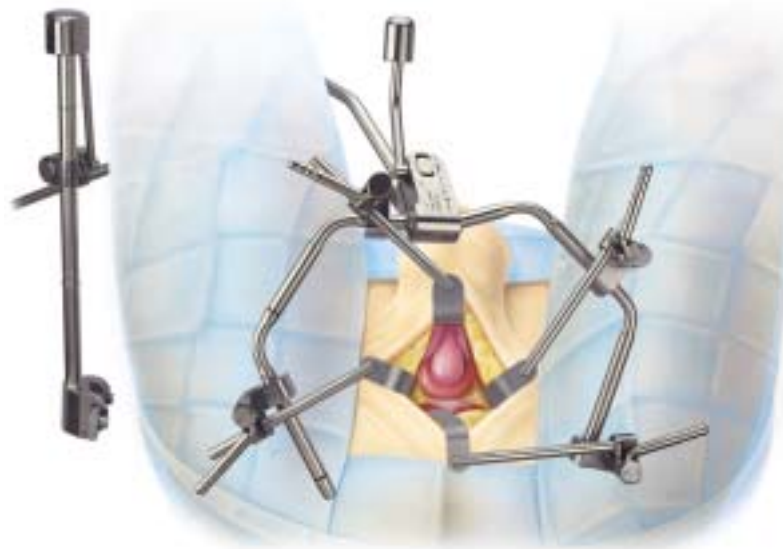

FASTSYSTEM® UROLOGY RETRACTOR SYSTEM • UF400

Qty	Part#	Item
1	4080	Omni-Clamp Sterile Field Post
1	4020	FastSystem Standard WISHBONE
6	4040	SnapClamp
2	3883	Mayo Swivel Retractor, 2" X 2" (5cm X 5cm)
2	3335	Mayo Swivel Retractor, 2-3/4" X 2" (7cm X 5cm)
1	3772	Fence Swivel Retractor, 4" X 6" (10.2cm X 15.2cm)
1	3854	Deaver Swivel Retractor, 1-1/2" X 6" (3.8cm X 15.2cm)
1	3784	Deaver Swivel Retractor, 2-3/4" X 4-1/2" (7cm X 11.4cm)
1	3788	Malleable Slotted Swivel Retractor, 2" X 6-1/2" (5cm X 16.5cm)
1	3790	Malleable Slotted Swivel Retractor, 3" X 6-1/2" (7.6cm X 16.5cm)
1	3792	Marshall Prostate Malleable Swivel Retractor, 3" X 6" (7.6cm X 15.2cm)
1	3794	Harrington Sweetheart Swivel Retractor, 2" X 5" (5cm X 12.7cm)
1	3796	Harrington Sweetheart Swivel Retractor, 2-1/2" X 7" (6.4cm X 17.8cm)
1	3798	Splanchnic Swivel Retractor, 1-1/2" X 4" (3.8cm X 10.2cm)

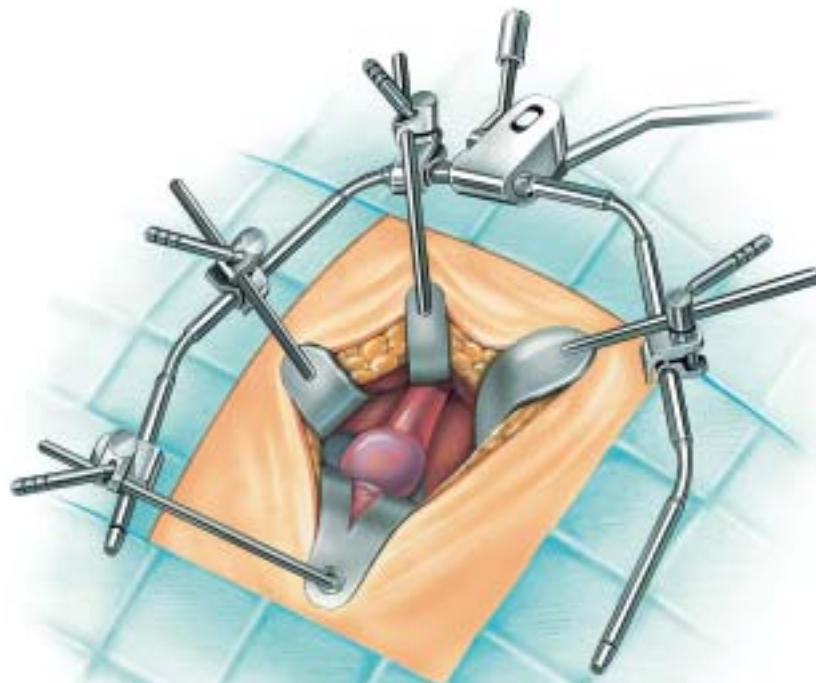

FASTSYSTEM® EXPANDED UROLOGY RETRACTOR SYSTEM • UF450

Qty	Part#	Item
1	4080	Omni-Clamp Sterile Field Post
1	4020	FastSystem Standard WISHBONE
8	4040	SnapClamp
2	3335	Mayo Swivel Retractor, 2-3/4" X 2" (7cm X 5cm)
1	3588	Extension Arm, Hinged
2	3883	Mayo Swivel Retractor, 2" X 2" (5cm X 5cm)
1	3772	Fence Swivel Retractor, 4" X 6" (10.2cm X 15.2cm)
1	3784	Deaver Swivel Retractor, 2-3/4" X 4-1/2" (7cm X 11.4cm)
1	3788	Malleable Slotted Swivel Retractor, 2" X 6-1/2" (5cm X 16.5cm)
1	3790	Malleable Slotted Swivel Retractor, 3" X 6-1/2" (7.6cm X 16.5cm)
1	3792	Marshall Prostate Malleable Swivel Retractor, 3" X 6" (7.6cm X 15.2cm)
1	3794	Harrington Sweetheart Swivel Retractor, 2" X 5" (5cm X 12.7cm)
1	3796	Harrington Sweetheart Swivel Retractor, 2-1/2" X 7" (6.4cm X 17.8cm)
1	3798	Splanchnic Swivel Retractor, 1-1/2" X 4" (3.8cm X 10.2cm)
1	3854	Deaver Swivel Retractor, 1-1/2" X 6" (3.8cm X 15.2cm)

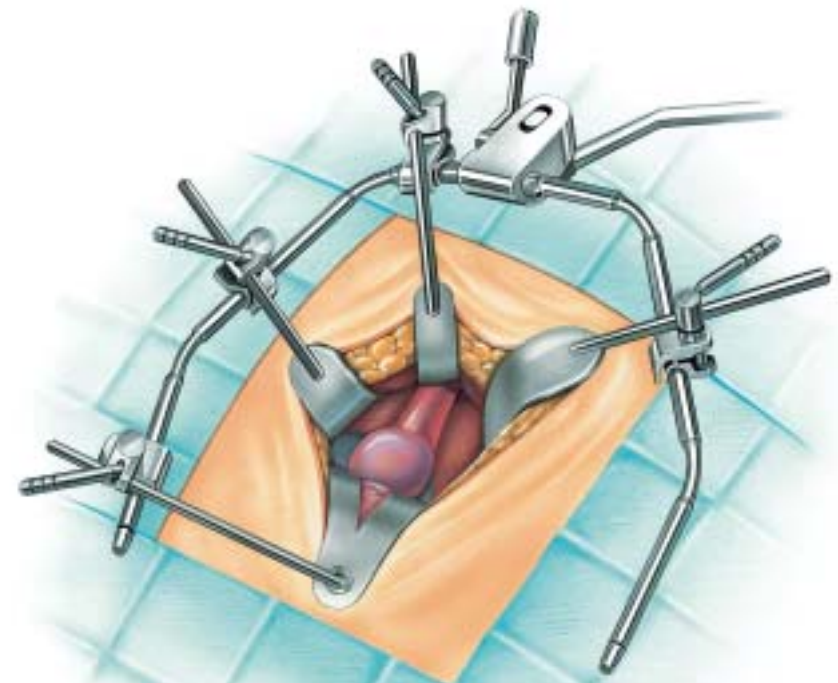

NEW

FASTSYSTEM® STONEY PERIPHERAL VASCULAR RETRACTOR SYSTEM • VF100

Qty	Part#	Item
1	4080	Omni-Clamp Sterile Field Post
1	4985	FastSystem Small WISHBONE
4	4040	SnapClamp
1	4956	Richardson Stoney Retractor, 3/4" X 2" (1.9cm X 5cm)
1	4960	Richardson Swivel Retractor, 1" X 1" (2.5cm X 2.5cm)
1	4957	Rake Retractor, 7/8" X 1" (2.2cm X 2.5cm)
1	4958	Rake Retractor, 7/8" X 1/2" (2.2cm X 1.3cm)
1	4959	Richardson Swivel Retractor, 3/4" X 1" (1.9cm X 2.5cm)
1	4961	Richardson Swivel Retractor, 1" X 2" (2.5cm X 5cm)

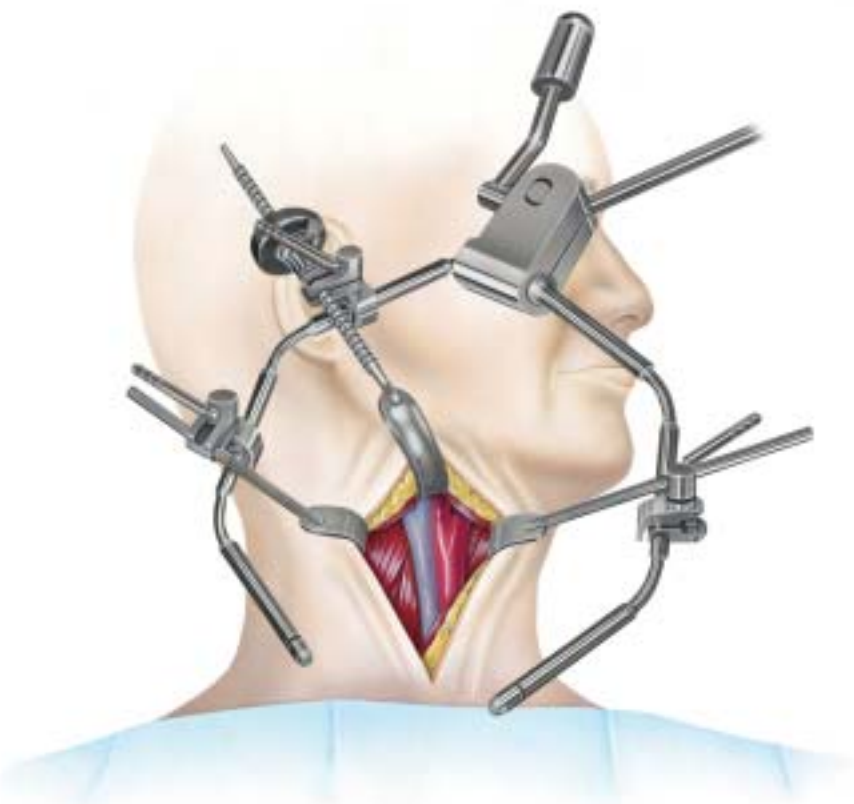

FASTSYSTEM® VASCULAR RETRACTOR SYSTEM • VF400

Qty	Part#	Item
1	4080	Omni-Clamp Sterile Field Post
1	4020	FastSystem Standard WISHBONE
8	4040	SnapClamp
2	3335	Mayo Swivel Retractor, 2-3/4" X 2" (7cm X 5cm)
1	3397	Mayo Swivel Retractor, 3-1/2" X 2" (8.9cm X 5cm)
1	3772	Fence Swivel Retractor, 4" X 6" (10.2cm X 15.2cm)
1	3888	Splanchnic Swivel Retractor, 2" X 4-1/2" (5cm X 11.4cm)
1	3774	Splanchnic Swivel Retractor, 2" X 6" (5cm X 15.2cm)
2	4928	Renal Vein Swivel Retractor, 1" X 6" (2.5cm X 15.2cm)
1	3784	Deaver Swivel Retractor, 2-3/4" X 4-1/2" (7cm X 11.4cm)
1	3788	Malleable Slotted Swivel Retractor, 2" X 6-1/2" (5cm X 16.5cm)
1	3790	Malleable Slotted Swivel Retractor, 3" X 6-1/2" (7.6cm X 16.5cm)
1	3794	Harrington Sweetheart Swivel Retractor, 2" X 5" (5cm X 12.7cm)

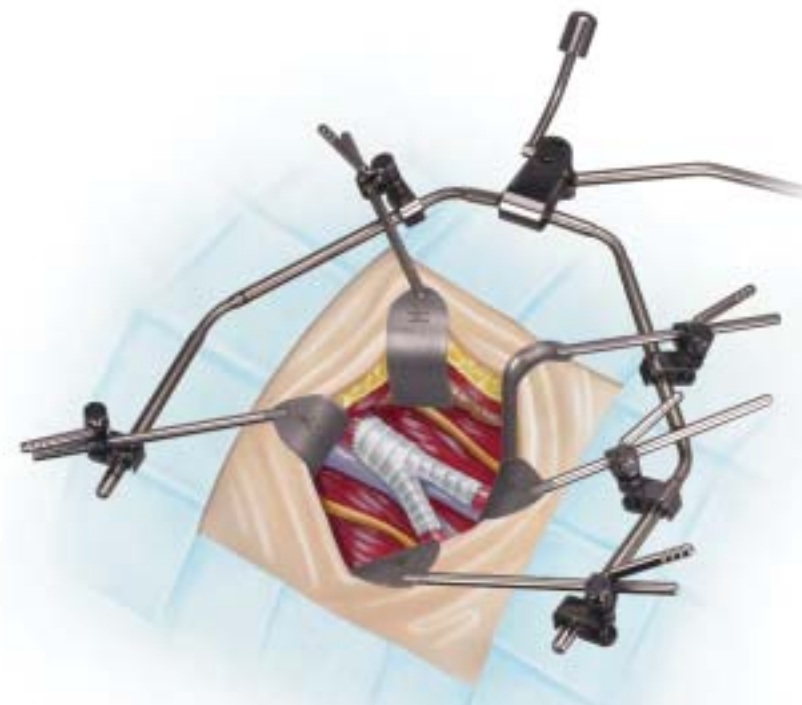

FASTSYSTEM® EXPANDED VASCULAR RETRACTOR SYSTEM • VF450

Qty	Part#	Item
1	4080	Omni-Clamp Sterile Field Post
1	4020	FastSystem Standard WISHBONE
10	4040	SnapClamp
1	3588	Extension Arm, Hinged
2	3335	Mayo Swivel Retractor, 2-3/4" X 2" (7cm X 5cm)
1	3397	Mayo Swivel Retractor, 3-1/2" X 2" (8.9cm X 5cm)
1	3772	Fence Swivel Retractor, 4" X 6" (10.2cm X 15.2cm)
1	3888	Splanchnic Swivel Retractor, 2" X 4-1/2" (5cm X 11.4cm)
1	3774	Splanchnic Swivel Retractor, 2" X 6" (5cm X 15.2cm)
2	4928	Renal Vein Swivel Retractor, 1" X 6" (2.5cm X 15.2cm)
1	3784	Deaver Swivel Retractor, 2-3/4" X 4-1/2" (7cm X 11.4cm)
1	3788	Malleable Slotted Swivel Retractor, 2" X 6-1/2" (5cm X 16.5cm)
1	3790	Malleable Slotted Swivel Retractor, 3" X 6-1/2" (7.6cm X 16.5cm)
1	3794	Harrington Sweetheart Swivel Retractor, 2" X 5" (5cm X 12.7cm)



NEW

FASTSYSTEM® UPPER ABDOMINAL RETRACTOR SYSTEM • BF200

Qty	Part#	Item
2	4944	Omni-Clamp Sterile Field Post, Double Joint
1	4943	Standard Cross Bar
1	4940	Hinged Cross Bar (Wide)
7	4040	SnapClamp
2	3759	Arm, Angled 8" X 18" (20.3cm X 45.7cm)
1	3091	Doherty-Harrington Retractor Blade, 5-1/2" X 3-1/2" (14cm X 8.9cm)
2	3094	Sternal Retractor, 3" X 3" (7.6cm X 7.6cm)
2	3536	Mayo Swivel Retractor, 3-1/2" X 2-3/4" (8.9cm X 7cm)
1	3623	Blade Holder, 9" Assy. (22.9cm)
1	3872	Malleable Swivel Retractor, 2" X 6-1/2" (5cm X 16.5cm)
1	3876	Malleable Swivel Retractor, 3" X 6-1/2" (7.6cm X 16.5cm)

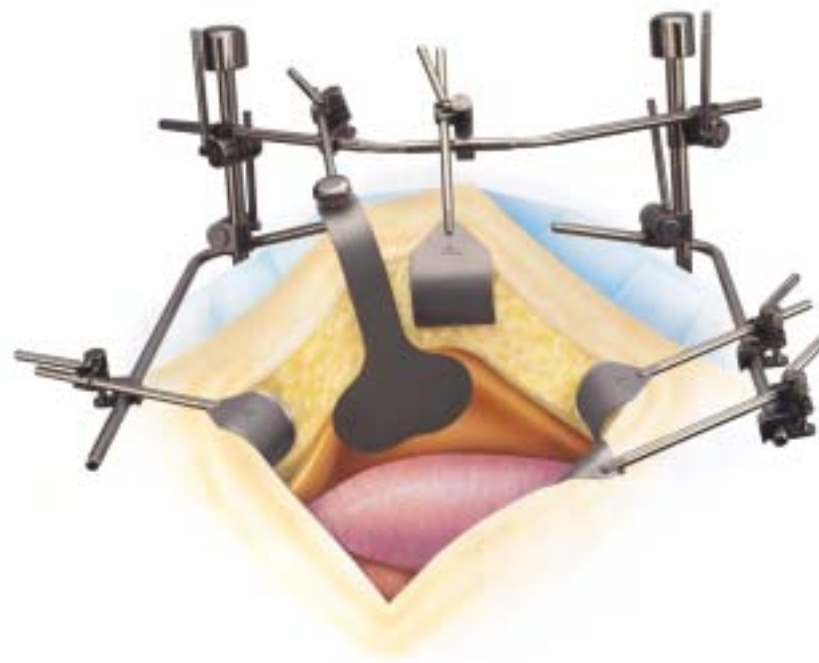

OMNI-LAPOTRACT® LAPAROSCOPIC SCOPE & INSTRUMENT HOLDER

LS50 Omni-LapoTract

Qty	Part#	Item
1	4547	Universal Clamp
1	3890	Instrument Holder

LS100 Omni-LapoTract System

Qty	Part#	Item
1	3700	Omni-Clamp Sterile Field Post
1	3720	Lapo-Clamp 5/10mm
1	3732	Arm, Angled, 55 Degree, 7" X 16" (17.8cm X 40.6cm)
1	3740	Flex Clamp

LS150 Omni-LapoTract System

Qty	Part#	Item
1	3700	Omni-Clamp Sterile Field Post
2	3720	Lapo-Clamp 5/10mm
1	3732	Arm, Angled, 55 Degree, 7" X 16" (17.8cm X 40.6cm)
2	3740	Flex Clamp

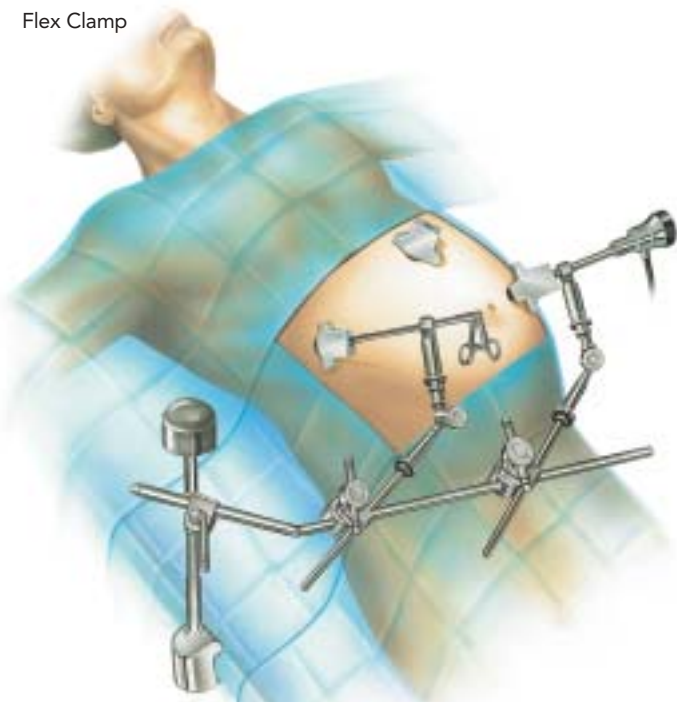

SPINE-TRACT® ANTERIOR LUMBAR RETRACTOR SYSTEM • AF400

Qty	Part#	Item
1	4080	Omni-Clamp Sterile Field Post
1	4020	FastSystem Standard WISHBONE
6	4040	SnapClamp
2	4922	Aluminum, Renal Vein Swivel Retractor, 1" X 8" (2.5cm X 20.3cm)
2	3974	Aluminum, Mayo Swivel Retractor, 2-3/4" X 2" (7cm X 5cm)
1	3975	Aluminum, Mayo Swivel Retractor, 3-1/2" X 2" (8.9cm X 5cm)
1	3976	Aluminum, Fence Swivel Retractor, 4" X 6" (10.2cm X 15.2cm)
1	3977	Aluminum, Splanchnic Swivel Retractor, 2" X 4-1/2" (5cm X 11.4cm)
1	3978	Aluminum, Splanchnic Swivel Retractor, 2" X 6" (5cm X 15.2cm)
2	4921	Aluminum, Renal Vein Swivel Retractor, 1" X 6" (2.5cm X 15.2cm)
1	3980	Aluminum, Deaver Swivel Retractor, 2-3/4" X 4-1/2" (7cm X 11.4cm)
1	3981	Aluminum, Malleable Swivel Retractor, 2" X 6-1/2" (5cm X 16.5cm)
1	3982	Aluminum, Malleable Swivel Retractor, 3" X 6-1/2" (7.6cm X 16.5cm)
1	3983	Aluminum, Harrington Sweetheart Retractor, 2" X 5" (5cm X 12.7cm)
2	4920	Aluminum, Renal Vein Swivel Retractor, 1" X 4" (2.5cm X 10.2cm)
1	4019	Aluminum, Splanchnic Swivel Retractor, 1-1/2" X 6" (3.8cm X 15.2cm)
1	4105	Aluminum, Splanchnic Swivel Retractor, 2" X 8" (5cm X 20.3cm)

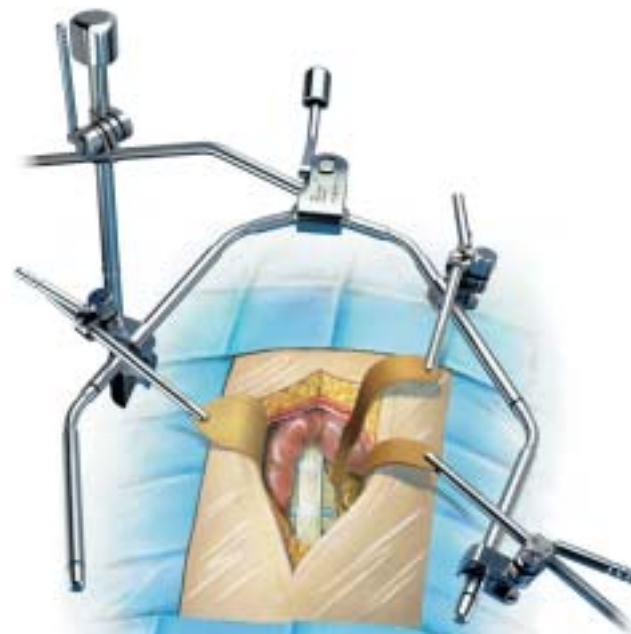

SPINE-TRACT® ANTERIOR CERVICAL RETRACTOR SYSTEM • CF300

Qty	Part#	Item
1	4080	Omni-Clamp Sterile Field Post
1	4020	FastSystem Standard WISHBONE
5	4040	SnapClamp
5	3910	FastSnap Blade Holder
1	3914	Cloward Blade, 1/2" X 3" (1cm X 7.6cm)
1	3915	Cloward Tapered Blade, 3/4" X 1-1/4" (2cm X 3cm)
1	3916	Cloward Tapered Blade, 3/4" X 1-1/2" (2cm X 3.8cm)
1	3917	Lateral Blade (w/lip), 3/4" X 2" (2cm X 5cm)
1	3918	Lateral Blade (w/lip), 1" X 2" (2.5cm X 5cm)
1	3919	Lateral Blade (w/lip), 1" X 3" (2.5cm X 7.6cm)
1	3921	Medial Blade (w/o lip), 1-1/4" X 2-3/4" (3cm X 7cm)
1	3922	Medial Blade (w/o lip), 1-1/2" X 2-3/4" (3.8cm X 7cm)
1	3923	Medial Blade (w/o lip), 1-1/2" X 3-1/2" (3.8cm X 8.9cm)
1	3924	Sub-Mandibular Malleable Blade, 1" X 4" (2.5cm X 10.2cm)
1	3925	Sub-Mandibular Malleable Blade, 1" X 6" (2.5cm X 15.2cm)
1	3926	Meyerding Blade, 1" X 3" (2.5cm X 7.6cm)
1	3927	Meyerding Blade, 2" X 2-1/2" (5cm X 6.4cm)
1	3928	Meyerding Blade, 2" X 3" (5cm X 7.6cm)
1	3929	Richardson Blade, 3/4" X 2" (2cm X 5cm)
1	3931	Modified Meyerding Blade, Right
1	3932	Modified Meyerding Blade, Left



SPINE-TRACT® POSTERIOR LUMBAR RETRACTOR SYSTEM • LF400

Qty	Part#	Item
1	4571	Omni Clamp Sterile Field Post
1	4991	Lumbar Retractor Frame
4	3920	Articulating Blade Holder
2	4400	Meyerding Blade, 3/4" X 2" (2cm X 5cm), Radiolucent
2	4401	Meyerding Blade, 1" X 2-1/2" (2.5cm X 6.4cm), Radiolucent
2	4402	Meyerding Blade, 1" X 3" (2.5cm X 7.6cm), Radiolucent
2	4403	Meyerding Blade, 2" X 2-1/2" (5cm X 6.4cm), Radiolucent
2	4404	Meyerding Blade, 2" X 3" (5cm X 7.6cm), Radiolucent
2	4405	Meyerding Blade, 2" X 4" (5cm X 10.2cm), Radiolucent
2	4406	Meyerding Blade, 2" X 5" (5cm X 12.7cm), Radiolucent
2	4407	Doubled Angled Blade, 1" X 3" (2.5cm X 7.6cm), Radiolucent



ARTHRO-TRACT® SUPINE RETRACTOR SYSTEM • HF500

Qty Part# Item

- 1 4571 Omni Clamp Sterile Field Clamp
- 4 4574 Articulating Blade Holder
- 1 4580 Anterior Frame Support Arm
- 1 4592 Mulier Blade 1" X 2-1/2" (2.5cm X 6.4cm)
- 1 4593 Mulier Blade 1" X 3-1/2" (2.5cm X 8.9cm)
- 1 4594 Mulier Blade 1" X 4-1/2" (2.5cm X 11.4cm)
- 1 4595 Mulier Blade 1" X 5-1/2" (2.5cm X 14cm)
- 1 4596 Mulier Blade 2" X 2-1/2" (5cm X 6.4cm)
- 1 4597 Mulier Blade 2" X 3-1/2" (5cm X 8.9cm)
- 1 4598 Mulier Blade 2" X 4-1/2" (5cm X 11.4cm)
- 1 4599 Mulier Blade 2" X 5-1/2" (5cm X 14cm)
- 1 4600 Meyerding Blade 1" X 2-1/2" (2.5cm X 6.4cm)
- 1 4601 Meyerding Blade 1" X 3-1/2" (2.5cm X 8.9cm)
- 1 4602 Meyerding Blade 1" X 4-1/2" (2.5cm X 11.4cm)
- 1 4603 Meyerding Blade 1" X 5-1/2" (2.5cm X 14cm)
- 1 4604 Meyerding Blade 2" X 2-1/2" (5cm X 6.4cm)
- 1 4605 Meyerding Blade 2" X 3-1/2" (5cm X 8.9cm)
- 1 4606 Meyerding Blade 2" X 4-1/2" (5cm X 11.4cm)
- 1 4607 Meyerding Blade 2" X 5-1/2" (5cm X 14cm)
- 1 4609 Anterior Long Frame Arm
- 1 4610 Anterior Short Frame Arm
- 1 4615 Bone Hook
1-3/4" Deep (4.4cm)
- 1 4618 Bone Hook
3" Deep (7.6cm)
- 1 4621 Bone Hook
4" Deep (10.2cm)
- 1 4622 Bone Hook
5" Deep (12.7cm)
- 3 4950 Arthro-Strap Blade Holder

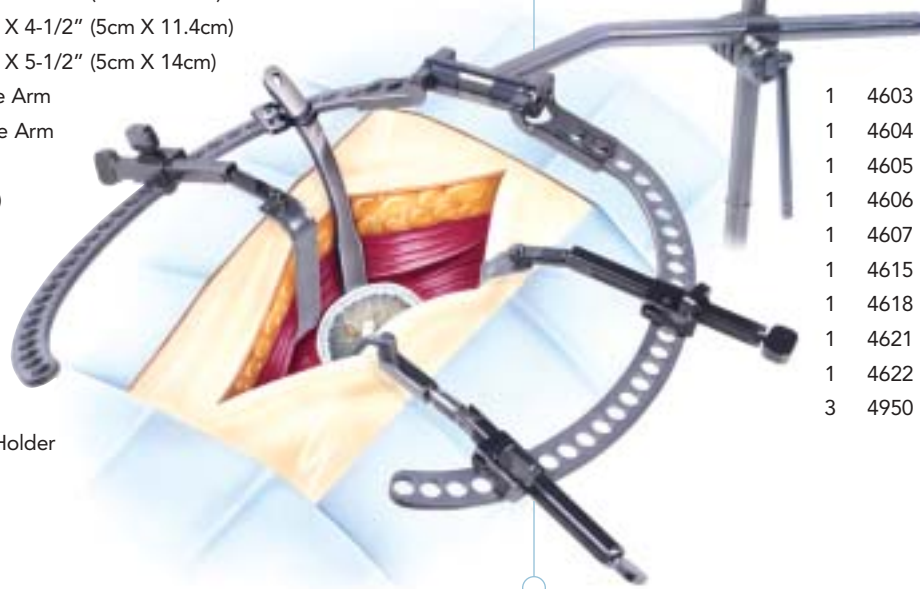

ARTHRO-TRACT® LATERAL RETRACTOR SYSTEM • HF600

Qty Part# Item

- 1 4571 Omni Clamp Sterile Field Clamp
- 1 4587 Frame Support Arm
- 4 4574 Articulating Blade Holder
- 1 4578 Frame Arm
- 1 4585 Frame Arm
- 1 4592 Mulier Blade 1" X 2-1/2" (2.5cm X 6.4cm)
- 1 4593 Mulier Blade 1" X 3-1/2" (2.5cm X 8.9cm)
- 1 4594 Mulier Blade 1" X 4-1/2" (2.5cm X 11.4cm)
- 1 4595 Mulier Blade 1" X 5-1/2" (2.5cm X 14cm)
- 1 4596 Mulier Blade 2" X 2-1/2" (5cm X 6.4cm)
- 1 4597 Mulier Blade 2" X 3-1/2" (5cm X 8.9cm)
- 1 4598 Mulier Blade 2" X 4-1/2" (5cm X 11.4cm)
- 1 4599 Mulier Blade 2" X 5-1/2" (5cm X 14cm)
- 1 4600 Meyerding Blade 1" X 2-1/2" (2.5cm X 6.4cm)
- 1 4601 Meyerding Blade 1" X 3-1/2" (2.5cm X 8.9cm)
- 1 4602 Meyerding Blade 1" X 4-1/2" (2.5cm X 11.4cm)
- 1 4603 Meyerding Blade 1" X 5-1/2" (2.5cm X 14cm)
- 1 4604 Meyerding Blade 2" X 2-1/2" (5cm X 6.4cm)
- 1 4605 Meyerding Blade 2" X 3-1/2" (5cm X 8.9cm)
- 1 4606 Meyerding Blade 2" X 4-1/2" (5cm X 11.4cm)
- 1 4607 Meyerding Blade 2" X 5-1/2" (5cm X 14cm)
- 1 4615 Bone Hook 1-3/4" Deep (4.4cm)
- 1 4618 Bone Hook 3" Deep (7.6cm)
- 1 4621 Bone Hook 4" Deep (10.2cm)
- 1 4622 Bone Hook 5" Deep (12.7cm)
- 3 4950 Arthro-Strap Blade Holder



ARTHRO-TRACT® SUPINE RETRACTOR SYSTEM • HF800

Qty Part# Item

- 1 4571 Sterile Field Clamp
- 2 4574 Articulating Blade Holder
- 1 4580 Anterior Frame Support Arm
- 1 4593 Mulier Blade 1" X 3-1/2" (2.5cm X 8.9cm)
- 1 4594 Mulier Blade 1" X 4-1/2" (2.5cm X 11.4cm)
- 1 4595 Mulier Blade 1" X 5-1/2" (2.5cm X 14cm)
- 1 4601 Meyerding Blade 1" X 3-1/2" (2.5cm X 8.9cm)
- 1 4602 Meyerding Blade 1" X 4-1/2" (2.5cm X 11.4cm)
- 1 4603 Meyerding Blade 1" X 5-1/2" (2.5cm X 14cm)
- 1 4609 Anterior Long Frame Arm
- 1 4610 Anterior Short Frame Arm
- 4 4950 Arthro-Strap Blade Holder

ARTHRO-TRACT® LATERAL RETRACTOR SYSTEM • HF900

Qty Part# Item

- 1 4571 Sterile Field Clamp
- 2 4574 Articulating Blade Holder
- 1 4587 Frame Support Arm
- 1 4578 Frame Arm
- 1 4585 Frame Arm
- 1 4593 Mulier Blade 1" X 3-1/2" (2.5cm X 8.9cm)
- 1 4594 Mulier Blade 1" X 4-1/2" (2.5cm X 11.4cm)
- 1 4595 Mulier Blade 1" X 5-1/2" (2.5cm X 14cm)
- 1 4601 Meyerding Blade 1" X 3-1/2" (2.5cm X 8.9cm)
- 1 4602 Meyerding Blade 1" X 4-1/2" (2.5cm X 11.4cm)
- 1 4603 Meyerding Blade 1" X 5-1/2" (2.5cm X 14cm)
- 4 4950 Arthro-Strap Retractor Holder

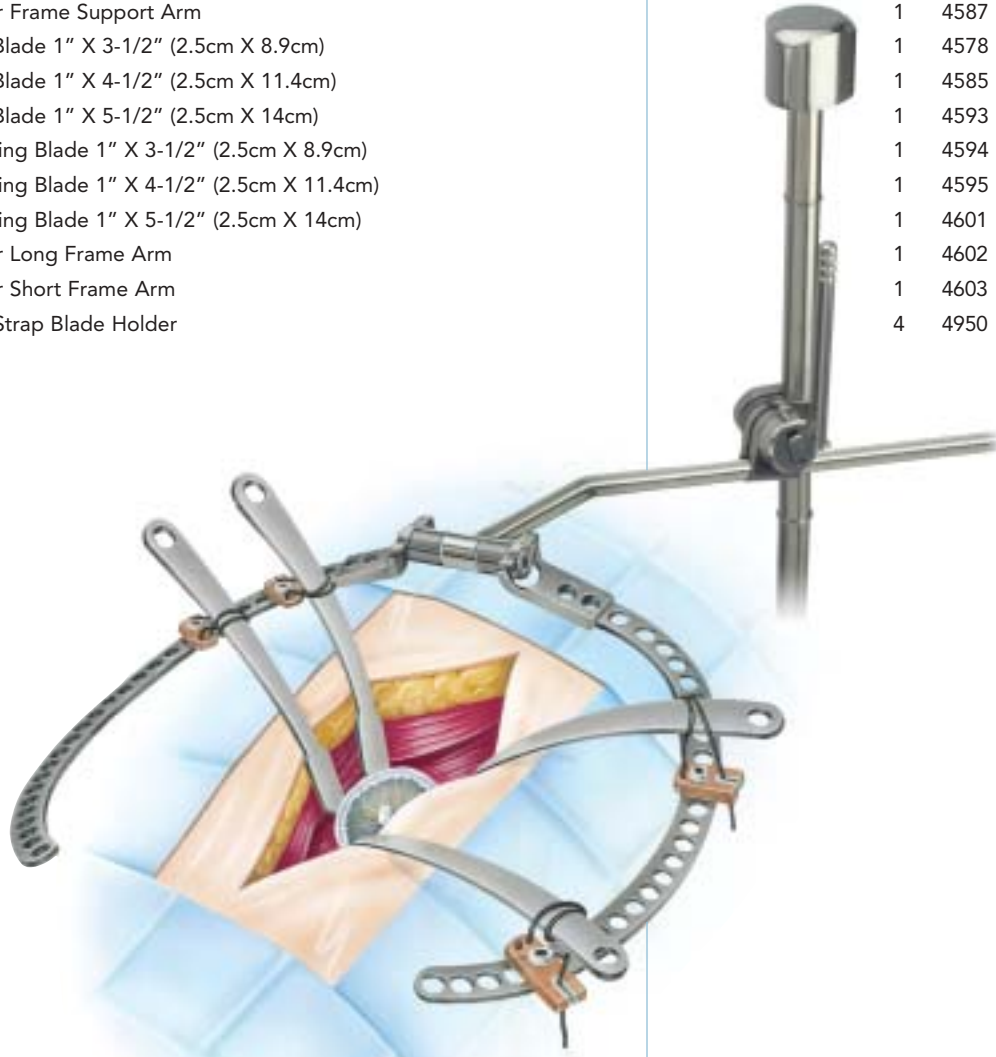

OBESITY BLADE KIT • OK200

Qty	Part#	Item
2	3529	Splanchnic Retractor, 2" X 8" (5cm X 20.3cm)
2	4929	Renal Vein Retractor, 1" X 8" (2.5cm X 20.3cm)
1	3531	Deaver Retractor, 2-3/4" X 8" (7cm X 20.3cm)
2	3536	Mayo Swivel Retractor, 3-1/2" X 2-3/4" (8.9cm X 7cm)
1	3856	Fence Swivel Retractor, 4" X 8" (10.2cm X 20.3cm)
1	3874	Malleable Swivel Retractor, 2" X 8" (5cm X 20.3cm)
1	3878	Malleable Swivel Retractor, 3" X 8" (7.6cm X 20.3cm)
1	3882	Malleable Swivel Retractor, 4" X 8" (10.2cm X 20.3cm)

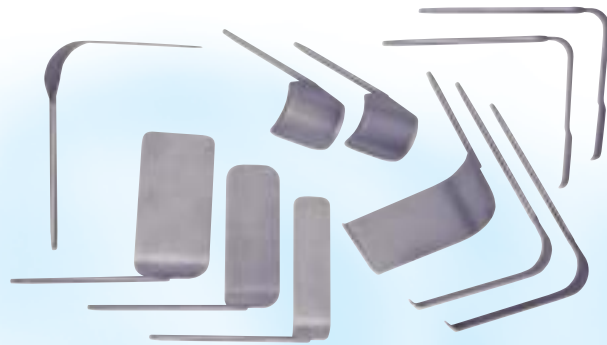

WISHBONE® EXTENSION ARM KIT • EK300

Qty	Part#	Item
2	4040	SnapClamp
1	3588	Extension Arm, Hinged

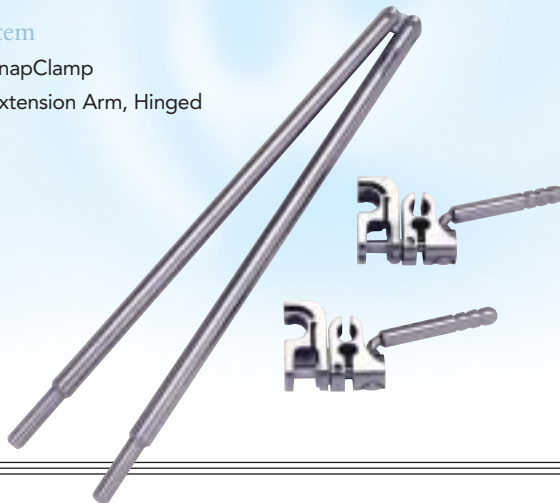

RADIOLUCENT ANTERIOR LUMBAR BLADE KIT • SK500

Qty	Part#	Item
2	4922	Aluminum, Renal Vein Retractor, 1" X 8" (2.5cm X 20.3cm)
2	3974	Aluminum, Mayo Swivel Retractor, 2-3/4" X 2" (7cm X 5cm)
1	3975	Aluminum, Mayo Swivel Retractor, 3-1/2" X 2" (8.9cm X 5cm)
1	3976	Aluminum, Fence Swivel Retractor, 4" X 6" (10.2cm X 15.2cm)
1	3977	Aluminum, Splanchnic Swivel Retractor, 2" X 4-1/2" (5cm X 11.4cm)
1	3978	Aluminum, Splanchnic Swivel Retractor, 2" X 6" (5cm X 15.2cm)
2	4921	Aluminum, Renal Vein Swivel Retractor, 1" X 6" (2.5cm X 15.2cm)
1	3980	Aluminum, Deaver Swivel Retractor, 2-3/4" X 4-1/2" (7cm X 11.4cm)
1	3981	Aluminum, Malleable Swivel Retractor, 2" X 6-1/2" (5cm X 16.5cm)
1	3982	Aluminum, Malleable Swivel Retractor, 3" X 6-1/2" (7.6cm X 16.5cm)
1	3983	Aluminum, Harrington Sweetheart Retractor, 2" X 5" (5cm X 12.7cm)
2	4920	Aluminum, Renal Vein Swivel Retractor, 1" X 4" (2.5cm X 10.2cm)
1	4019	Aluminum, Splanchnic Swivel Retractor, 1-1/2" X 6" (3.8cm X 15.2cm)
1	4105	Aluminum, Splanchnic Swivel Retractor, 2" X 8" (5cm X 20.3cm)



CLAMPS

Clamps
SNAPCLAMP®
4040

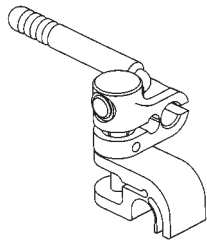

OMNI-CLAMP®
STERILE
FIELD POST
4080

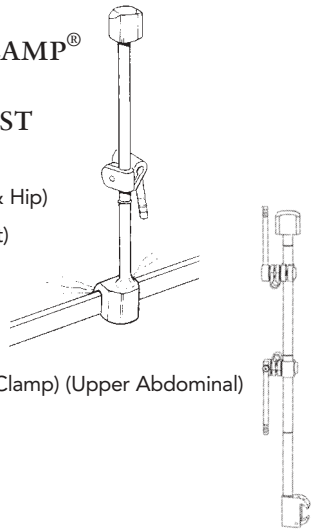

4571 (Lumbar & Hip)
3700 (LapoTract)

4944 (Double Clamp) (Upper Abdominal)

UNIBALL™ CLAMP
10015

For use with
 Wishbook™
 and
 Bookwalter™*
 Retractor Systems

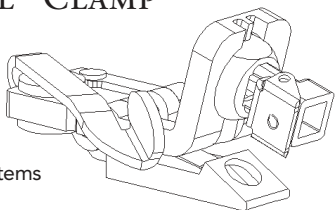

CLAMPS & FRAMES

UNIVERSAL RAIL CLAMP
4547

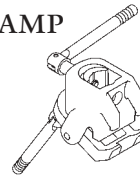

IMA RAIL CLAMP
3635

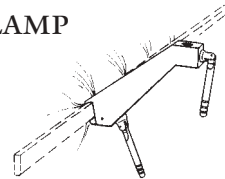

Frames

FASTSYSTEM STANDARD
WISHBONE®
4020

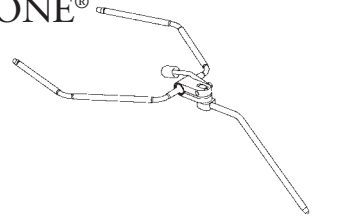

FASTSYSTEM SMALL
WISHBONE®
4985

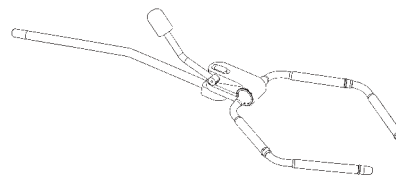

FRAMES

WISHBOOK™ FRAME
4640
 For use with Bookwalter™*
 Retractor Systems

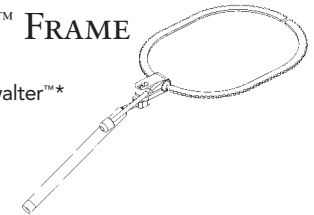

OMNI-RING® ROUND
4070
 12", W/Arm (30.5cm)

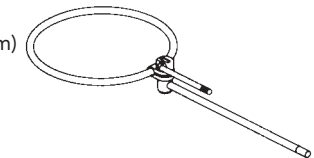

OMNI-RING® OVAL
4090
 12" X 18", W/Arm
 (30.5 X 45.7cm)

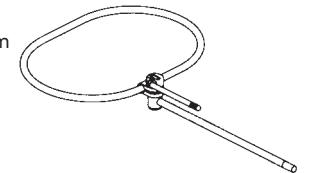

LUMBAR RETRACTOR FRAME
4991

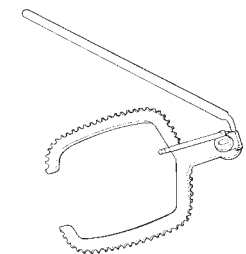

*BOOKWALTER is a trademark of John Bookwalter M.D., marketed by Codman & Shurtleff, Inc. Minnesota Scientific, Inc. and Omni-Tract Surgical are in no way related to, affiliated with or sponsored by John Bookwalter, M.D. or Codman & Shurtleff, Inc.

A = Aluminum Radiolucent **S** = Blades which utilize 3910, 4574 or 3920 blade holder
P = Plastic Radiolucent **U** = Universal, can be used with blade holders 3178, 3378, 3622, 3623, 3624

*Blades are satin finished to eliminate reflection from surgical lights.
 Dimensions are shown width x working depth.*

FRAMES & SUPPORT ARMS

PERINEAL EXTENSION ARM

4988
20" (51cm)



BENT PITTMAN IMA Post

3640



HINGED EXTENSION ARM

3588

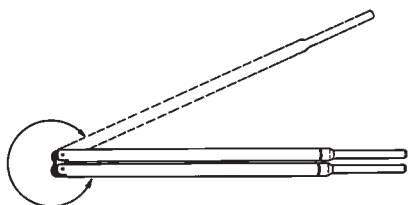

FRAMES & SUPPORT ARMS

ADJUSTABLE PITTMAN T POST
w/CLAMP ASSEMBLIES

3647

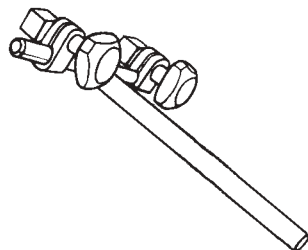

ARTHRO-TRACT® FRAME
SUPPORT ARM

4587

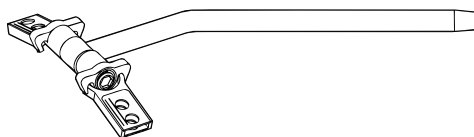

ARTHRO-TRACT® ANTERIOR
FRAME SUPPORT ARM

4580

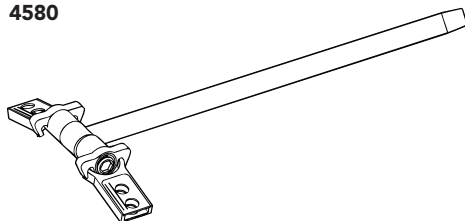

FRAMES & SUPPORT ARMS

HINGED CROSS BAR (WIDE)

4983
32" (81.3cm)

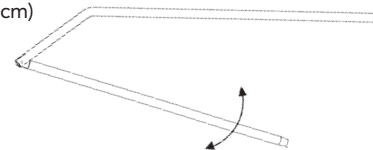

STANDARD CROSS BAR

4943
24" (61cm)

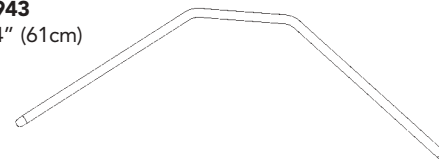

ANGLED SIDE ARM

3759
8" X 18" (20.3cm X 45.7cm)

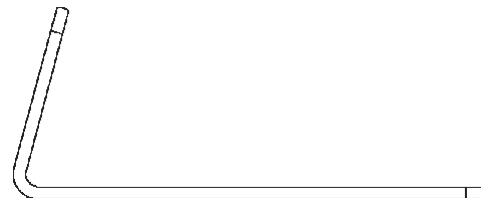

A = Aluminum Radiolucent
P = Plastic Radiolucent

S = Blades which utilize 3910, 4574 or 3920 blade holder
U = Universal, can be used with blade holders 3178, 3378, 3622, 3623, 3624

Blades are satin finished to eliminate reflection from surgical lights.
Dimensions are shown width x working depth.

FRAME ARMS

ARTHRO-TRACT® FRAME ARM

4578

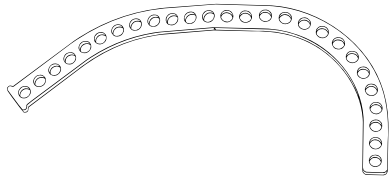

ARTHRO-TRACT® FRAME ARM

4585

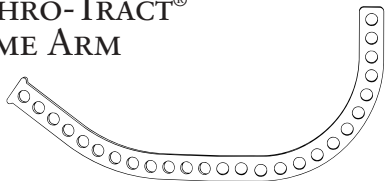

ARTHRO-TRACT® ANTERIOR LONG FRAME ARM

4609

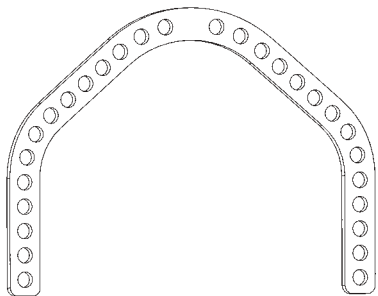

ARTHRO-TRACT® ANTERIOR SHORT FRAME ARM

4610

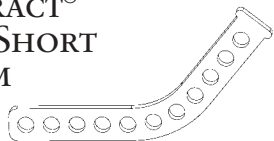

BLADE HOLDERS

Blade Holders

BLADE HOLDER

3178 8" (20.3cm) Micro Adj Complete

3622 6" (15.2cm), w/Knob (3626)

3623 9" (22.9cm), w/Knob (3626)

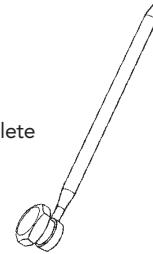

FASTSNAP BLADE HOLDER

3910 • S

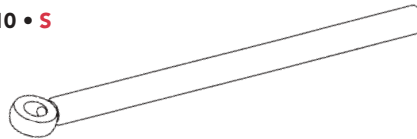

ARTICULATING BLADE HOLDER

3920 for use with posterior lumbar system

4574 for use with Arthro-Tract System

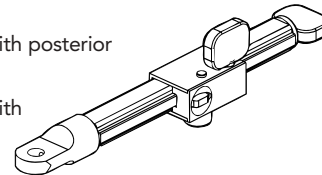

ARTHRO-STRAP™ RETRACTOR HOLDER

4950 for use with Arthro-Tract System - complete assembly which includes base and strap

10099 replacement straps only (non-sterile) 4/box

10100 replacement straps only (non-sterile) case of 3 boxes

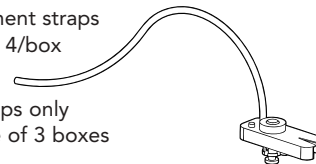

LAPOTRACT COMPONENTS

LAPOTRACT™

3720

5/10mm, Scope Holder

3900

Instrument Holder

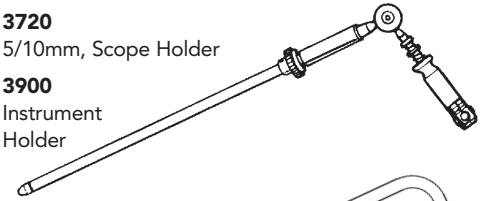

3890

Instrument Holder

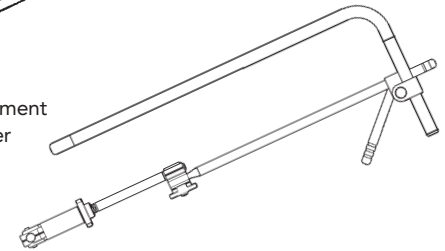

FLEX CLAMP™

3740

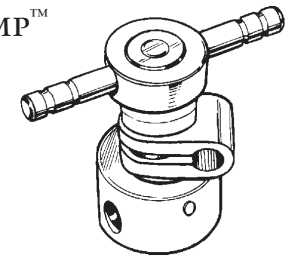

ANGLED ARM

3732

55 Degree, 7" X 16" (17.8cm X 40.6cm)



A = Aluminum Radiolucent
P = Plastic Radiolucent

S = Blades which utilize 3910, 4574 or 3920 blade holder
U = Universal, can be used with blade holders 3178, 3378, 3622, 3623, 3624

Blades are satin finished to eliminate reflection from surgical lights.
Dimensions are shown width x working depth.

RETRACTORS & BLADES

Retractors & Blades

ANTERIOR SWIVEL
RETRACTOR

4977

1-1/2" X 3" (3.8cm X 7.6cm)

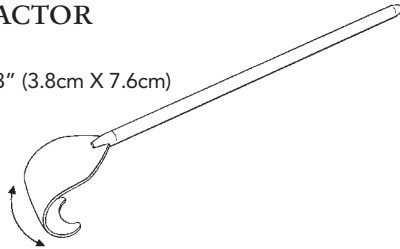

DEAVER RETRACTOR

3531

2-3/4" X 8" (7cm X 20.3cm)

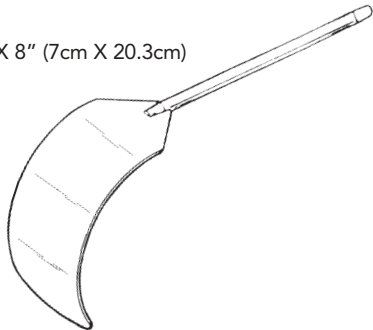

DEAVER SWIVEL RETRACTOR

3784

2-3/4" X 4-1/2" (7cm X 11.4cm)

3980 • A

2-3/4" X 4-1/2"
(7cm X 11.4cm)

3854

1-1/2" X 6"
(3.8cm X 15.2cm)

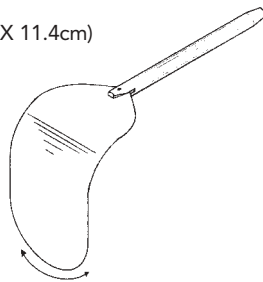

RETRACTORS & BLADES

HARRINGTON SWEETHEART
SWIVEL RETRACTOR

3794

2" X 5" (5cm X 12.7cm)

3796

2-1/2" X 7"
(6.4cm X 17.8cm)

3983 • A

2" X 5"
(5 cm X 12.7cm)

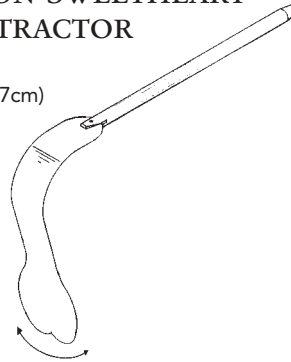

FENCE SWIVEL RETRACTOR

3892

4" X 5" (10.2cm X 12.7cm)

3772

4" X 6" (10.2cm X 15.2cm)

3976 • A

4" X 6" (10.2cm X 15.2cm)

3856

4" X 8" (12.7cm X 20.3cm)

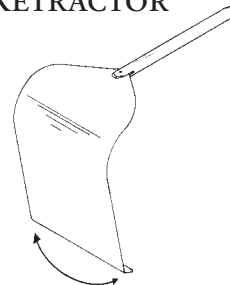

FINGER FENCE BLADE

3137 • U

3-1/2" X 6" (8.9cm X 15.2cm)

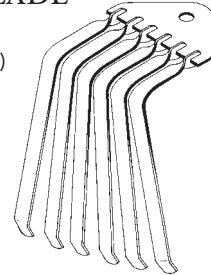

RETRACTORS & BLADES

POSTERIOR SWIVEL
RETRACTOR

4975

1-3/4" X 3"
(4.5cm X 7.6cm)

4976

1-3/4" X 4"
(4.5cm X 10.2cm)

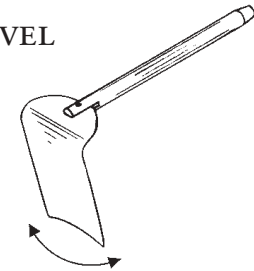

LIVER BLADES

3091 • U

Doherty-Harrington

5-1/2" X 3-1/2" (14cm X 8.9cm)

3092 • U

Doherty-GHL

4-1/4" X 3" (10.8cm X 7.6cm)

3093 • U

Lechner-Harrington

5" X 3-1/2" (12.7 X 8.9cm)

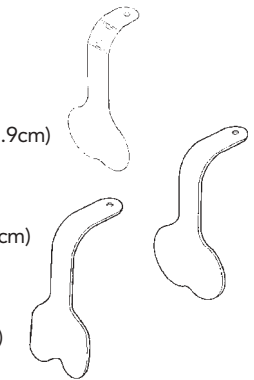

KELLY MODIFIED
RETRACTOR

3145

3" X 3"
(7.6cm X 7.6cm)

3146

3" X 3-1/2"
(7.6cm X 8.9cm)

3147

3" X 4" (7.6cm X 10.2cm)

3148

3" X 4-1/2" (7.6cm X 11.4cm)

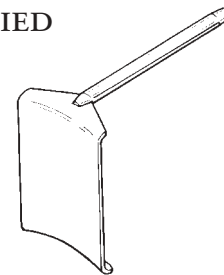

A = Aluminum Radiolucent
P = Plastic Radiolucent

S = Blades which utilize 3910, 4574 or 3920 blade holder
U = Universal, can be used with blade holders 3178, 3378, 3622, 3623, 3624

Blades are satin finished to eliminate reflection from surgical lights.
Dimensions are shown width x working depth.

RETRACTORS & BLADES

KELLY MODIFIED SWIVEL RETRACTOR

3906
2" X 3" (5cm X 7.6cm)

3907
2" X 4" (5cm X 10.2cm)

3908
2" X 5" (5cm X 12.7cm)

3909
2" X 6" (5cm X 15.2cm)

3862
3" X 2-1/2" (7.6cm X 6.4cm)

3864
3" X 4" (7.6cm X 10.2cm)

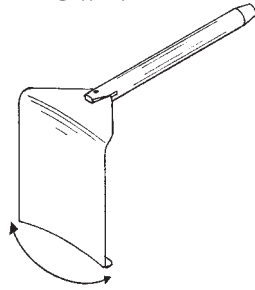

MALLEABLE SLOTTED SWIVEL BLADE

3592 • U
2" X 6-1/2" (5cm X 16.5cm)

3593 • U
3" X 6-1/2" (7.6cm X 16.5cm)

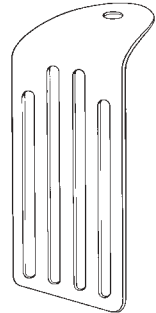

RETRACTORS & BLADES

MALLEABLE SLOTTED SWIVEL RETRACTOR

3911
1-1/2" X 6" (3.8cm X 15.2cm)

3788
2" X 6-1/2" (5cm X 16.5cm)

3790
3" X 6-1/2"
(7.6cm X 16.5cm)

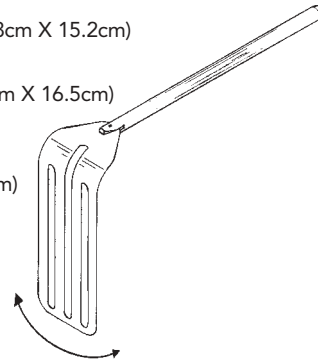

MALLEABLE SWIVEL BLADE

3151 • U
3" X 6-1/2" (7.6cm X 16.5cm)

3152 • U
4" X 6-1/2" (12.7cm X 16.5cm)

3533 • U
3" X 8" (7.6cm X 20.3cm)

3534 • U
4" X 8" (12.7cm X 20.3cm)

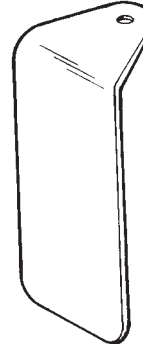

RETRACTORS & BLADES

MALLEABLE SWIVEL RETRACTOR

4963
1/2" X 1"
(1.3cm X 2.5cm)

4964
3/4" X 2"
(1.9cm X 5cm)

4965
3/4" X 3"
(1.9cm X 7.6cm)

4966
3/4" X 4"
(1.9cm X 10.2cm)

4967
1" X 1"
(2.5cm X 2.5cm)

4968
1" X 4"
(2.5cm X 10.2cm)

4969
1" X 5" (2.5cm X 12.7cm)

4970
1" X 6" (2.5cm X 15.2cm)

4971
1-1/2" X 3"
(3.8cm X 7.6cm)

4972
1-1/2" X 4"
(3.8cm X 10.2cm)

4973
1-1/2" X 5" (3.8cm X 12.7cm)

4974
1-1/2" X 6" (3.8cm X 15.2cm)

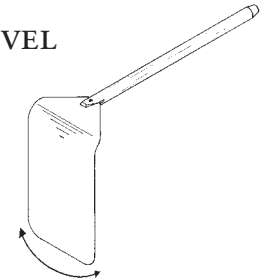

3870
1-1/2" X 7"
(3.8cm X 17.8cm)

3872
2" X 6-1/2"
(5cm X 16.5cm)

3981 • A
2" X 6-1/2"
(5cm X 16.5cm)

3874
2" X 8"
(5cm X 20.3cm)

3876
3" X 6-1/2"
(7.6cm X 16.5cm)

3982 • A
3" X 6-1/2"
(7.6cm X 16.5cm)

3878
3" X 8"
(7.6cm X 20.3cm)

3880
4" X 6-1/2"
(10.2cm X 16.5cm)

3882
4" X 8"
(10.2cm X 20.3cm)

A = Aluminum Radiolucent
P = Plastic Radiolucent

S = Blades which utilize 3910, 4574 or 3920 blade holder
U = Universal, can be used with blade holders 3178, 3378, 3622, 3623, 3624

*Blades are satin finished to eliminate reflection from surgical lights.
Dimensions are shown width x working depth.*

RETRACTORS & BLADES

MAYO SWIVEL RETRACTOR

4978

1" X 1" (2.5cm X 2.5cm)

4979

2" X 1-1/2" (5cm X 3.8cm)

4980

2" X 2" (5cm X 5cm)

4981

2-3/4" X 2" (7cm X 5cm)

3883

2" X 2" (5cm X 5cm)

3335

2-3/4" X 2" (7cm X 5cm)

3974 • A

2-3/4" X 2" (7cm X 5cm)

3866

2-3/4" X 3" (7cm X 7.6cm)

3397

3-1/2" X 2" (8.9cm X 5cm)

3975 • A

3-1/2" X 2" (8.9cm X 5cm)

3536

3-1/2" X 2-3/4" (8.9cm X 7cm)

3868

3-1/2" X 4" (8.9cm X 10.2cm)

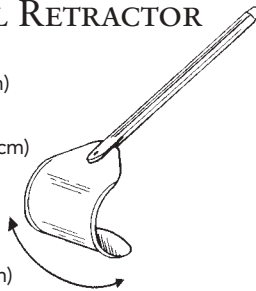

RETRACTORS & BLADES

RICHARDSON SWIVEL RETRACTOR

4959

3/4" X 1"
(1.9cm X 2.5cm)

3104

3/4" X 1-1/2"
(1.9cm X 3.8cm)

4960

1" X 1" (2.5cm X 2.5cm)

3105

1" X 1-1/2" (2.5cm X 3.8cm)

4961

1" X 2" (2.5cm X 5cm)

3220

1-1/2" X 1-1/2" (3.8cm X 3.8cm)

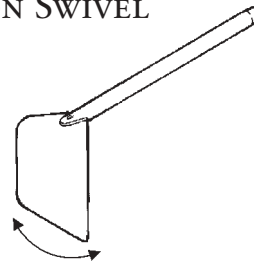

RICHARDSON STONEY RETRACTOR, MICRO ADJUSTABLE

4956

3/4" X 2" (1.9cm X 5cm)

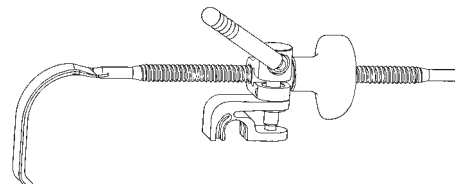

RETRACTORS & BLADES

GROIN SWIVEL RETRACTOR

3590

1-1/2" X 3-1/2"
(3.8cm X 8.9cm)

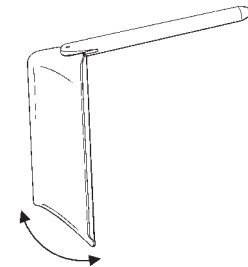

STERNAL RETRACTOR

3094

3" X 3" (7.6cm X 7.6cm)

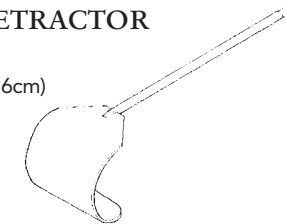

MARSHALL PROSTATE MALLEABLE SWIVEL RETRACTOR

3792

3" X 6" (7.6cm X 15.2cm)

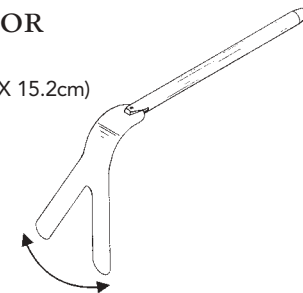

A = Aluminum Radiolucent
P = Plastic Radiolucent

S = Blades which utilize 3910, 4574 or 3920 blade holder
U = Universal, can be used with blade holders 3178, 3378, 3622, 3623, 3624

Blades are satin finished to eliminate reflection from surgical lights.
Dimensions are shown width x working depth.

RETRACTORS & BLADES

RENAL VEIN SWIVEL
RETRACTOR

4920 • A
1" X 4"
(2.5cm X 10.2cm)

4927
1" X 4"
(2.5cm X 10.2cm)

4921 • A
1" X 6" (2.5cm X 15.2cm)

4928
1" X 6" (2.5cm X 15.2cm)

4922 • A
1" X 8" (2.5cm X 20.3cm)

4929
1" X 8" (2.5cm X 20.3cm)

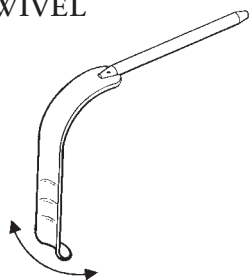

SPLANCHNIC RETRACTOR

3529
2" X 8" (5cm X 20.3cm)

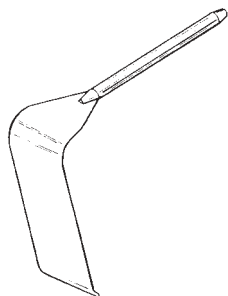

RETRACTORS & BLADES

SPLANCHNIC SWIVEL
RETRACTOR

4962
1-1/2 X 3-1/2
(3.8cm X 8.9cm)

3798
1-1/2" X 4"
(3.8cm X 10.2cm)

4019 • A
1-1/2" X 6" (3.8cm X 15.2cm)

3800
1-1/2" X 6" (3.8cm X 15.2cm)

3977 • A
2" X 4-1/2" (5cm X 11.4cm)

3888
2" X 4-1/2" (5cm X 11.4cm)

3978 • A
2" X 6" (5cm X 15.2cm)

3774
2" X 6" (5cm X 15.2cm)

4105 • A
2" X 8" (5cm X 20.3cm)

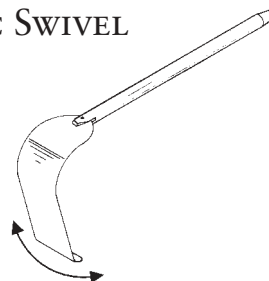

RAKE RETRACTOR

4958 (curved)
7/8" X 1/2" (2.2cm X 1.3cm)

4957
7/8" X 1" (2.2cm X 2.5cm)

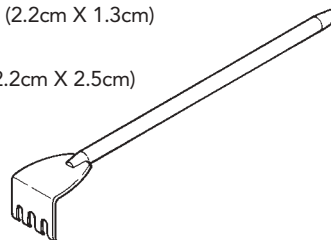

RETRACTORS & BLADES

LATERAL BLADE (w/LIP)

3917 • S
3/4" X 2" (2cm X 5cm)

3918 • S
1" X 2" (2.5cm X 5cm)

3919 • S
1" X 3" (2.5cm X 7.6cm)



SUB-MANDIBULAR
MALLEABLE BLADE

3925 • S
1" X 6" (2.5cm X 15.2cm)

3924 • S
1" X 4" (2.5cm X 10.2cm)

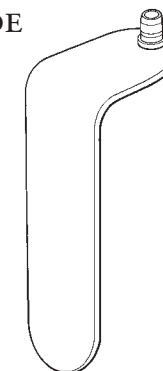

A = Aluminum Radiolucent
P = Plastic Radiolucent

S = Blades which utilize 3910, 4574 or 3920 blade holder
U = Universal, can be used with blade holders 3178, 3378, 3622, 3623, 3624

Blades are satin finished to eliminate reflection from surgical lights.
Dimensions are shown width x working depth.

RETRACTORS & BLADES

MEYERDING BLADE

4400 • S, P

3/4" X 2" (2cm X 5cm)

3933 • S

3/4" X 2" (2cm X 5cm)

4401 • S, P

1" X 2-1/2" (2.5cm X 6.4cm)

4600 • S

1" X 2-1/2" (2.5cm X 6.4cm)

3934 (Toothless) • S

1" X 2-1/2" (2.5cm X 6.4cm)

4402 • S, P

1" X 3" (2.5cm X 7.6cm)

4495 • S, G

1" X 3" (2.5cm X 7.6cm)

3926 • S

1" X 3" (2.5cm X 7.6cm)

4601 • S

1" X 3-1/2" (2.5cm X 8.9cm)

4602 • S

1" X 4-1/2" (2.5cm X 11.4cm)

4603 • S

1" X 5-1/2" (2.5cm X 14cm)

4403 • S, P

2" X 2-1/2" (5cm X 6.4cm)

4496 • S, G

2" X 2-1/2" (5cm X 6.4cm)

4604 • S

2" X 2-1/2" (5cm X 6.4cm)

3927 (Toothless) • S

2" X 2-1/2" (5cm X 6.4cm)

4404 • S, P

2" X 3" (5cm X 7.6cm)

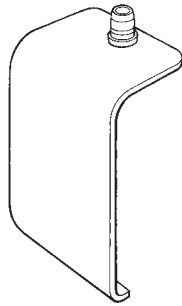

RETRACTORS & BLADES

MEYERDING BLADE *continued*

4497 • S, G

2" X 3" (5cm X 7.6cm)

3928 • S

2" X 3" (5cm X 7.6cm)

4605 • S

2" X 3-1/2" (5cm X 8.9cm)

4405 • S, P

2" X 4" (5cm X 10.2cm)

3935 • S

2" X 4" (5cm X 10.2cm)

4606 • S

2" X 4-1/2" (5cm X 11.4cm)

4406 • S, P

2" X 5" (5cm X 12.7cm)

3936 • S

2" X 5" (5cm X 12.7cm)

4607 • S

2" X 5-1/2" (5cm X 14cm)

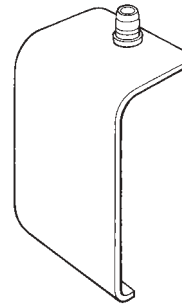

RETRACTORS & BLADES

MULIER BLADE

4592 • S

1" X 2-1/2" (2.5cm X 6.4cm)

4593 • S

1" X 3-1/2" (2.5cm X 8.9cm)

4594 • S

1" X 4-1/2" (2.5cm X 11.4cm)

4595 • S

1" X 5-1/2" (2.5cm X 14cm)

4596 • S

2" X 2-1/2" (5cm X 6.4cm)

4597 • S

2" X 3-1/2" (5cm X 8.9cm)

4598 • S

2" X 4-1/2" (5cm X 11.4cm)

4599 • S

2" X 5-1/2" (5cm X 14cm)

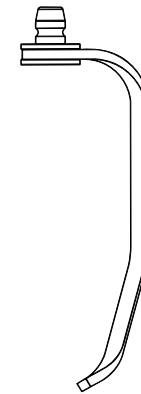

BONE HOOK

4615 • S

1-3/4" Deep (4.4cm)

4618 • S

3" Deep (7.6cm)

4621 • S

4" Deep (10.2cm)

4622 • S

5" Deep (12.7cm)

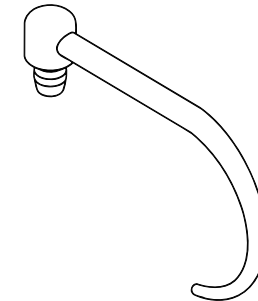

A = Aluminum Radiolucent
P = Plastic Radiolucent

S = Blades which utilize 3910, 4574 or 3920 blade holder
U = Universal, can be used with blade holders 3178, 3378, 3622, 3623, 3624
G = Thick Gauge (posterior lumbar)

Blades are satin finished to eliminate reflection from surgical lights.
Dimensions are shown width x working depth.

RETRACTORS & BLADES

MEDIAL BLADE, WITHOUT LIP

- 3921 • S**
1-1/4" X 2-3/4" (3cm X 7cm)
- 3922 • S**
1-1/2" X 2-3/4" (3.8cm X 7cm)
- 3923 • S**
1-1/2" X 3-1/2" (3.8cm X 8.5cm)

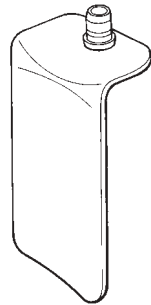

MODIFIED MEYERDING BLADE

- 3931 - Right • S**
2-3/4" X 3 (7cm X 7.6cm)
- 3932 - Left • S**
2-3/4" X 3 (7cm X 7.6cm)

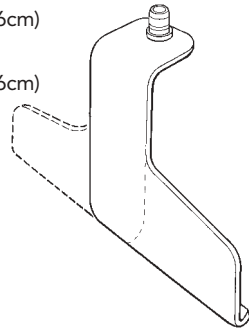

RICHARDSON BLADE

- 3929 • S**
3/4" X 2" (2cm X 5cm)

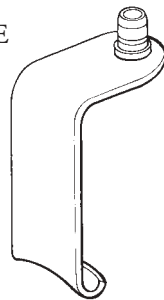

RETRACTORS & BLADES

DOUBLE ANGLED BLADE

- 3937 • S**
1" X 3" (2.5cm X 7.6cm)
- 4407 • P, S**
1" X 3" (2.5cm X 7.6cm)

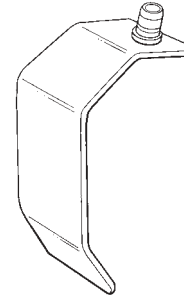

CLOWARD TAPERED BLADE

- 3915 • S**
3/4" X 1-1/4" (2cm X 3cm)
- 3916 • S**
3/4" X 1-1/2" (2cm X 3.8cm)

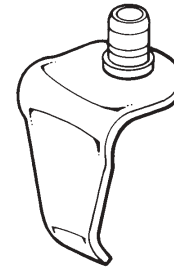

CLOWARD BLADE

- 3914 • S**
1/2" X 3" (1cm X 7.6cm)





RAKES & STERILIZATION PANS AND COVERS

Rakes

MICRO ADJUST IMA RAKE

-  **3259**
16-3/8" (41.5cm)

-  **3765 (Sharp Teeth)**
16-3/8" (41.5cm)

-  **3650 (CS200) Blunt Teeth, Squared**
16-3/8" (41.5cm)

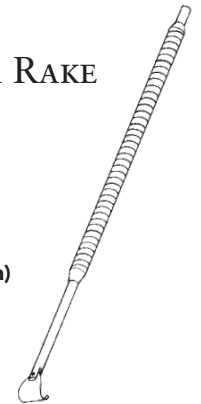

- 3630**
Micro Adjust Knob for use with all rakes (not shown)

Accessories

PAN/COVER SET

- 3424**
12-1/4" X 18-1/2" X 3-5/8"
(31.1cm X 47cm X 9.2cm)
Accommodates all systems
excluding 3005, 3008, UA200
- 3422 (BF200/UA200)**
12-1/2" X 26-1/2" X 3-5/8"
31.8cm X 67.3cm X 9.2cm

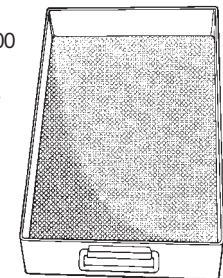

A = Aluminum Radiolucent **S** = Blades which utilize 3910, 4574 or 3920 blade holder
P = Plastic Radiolucent **U** = Universal, can be used with blade holders 3178, 3378, 3622, 3623, 3624

*Blades are satin finished to eliminate reflection from surgical lights.
 Dimensions are shown width x working depth.*

About Omni-Tract

Minnesota Scientific has researched, designed and developed surgical retraction systems for 30 years. The first Omni-Tract System was introduced in 1984 at the American College of Surgeons Congress in San Francisco, where it was acclaimed as a breakthrough in surgical retractor systems. Since that time, Omni-Tract has worked closely with some of the world's leading surgeons to provide answers to their most complex surgical exposure needs. Omni-Tract Surgical welcomes suggestions and new ideas from the field.

Warranty & Information

I. LIMITED WARRANTY

Omni-Tract Surgical, a division of Minnesota Scientific, Inc. (the "Manufacturer") warrants that each product it manufactures, sells, or distributes will be free from defects in materials and workmanship under normal use and service in their intended surgical purpose and only when maintained in accordance with recommended maintenance procedures. Product wear from normal use is excluded from the terms of the warranty. The period during which such limited warranty is applicable is as follows:

Surgical Retractor SystemsLifetime
	(Effective 11/1/1991)
Malleable, Plastic, Aluminum	
Retractor Blades and Arthro-Strap30 Days

CUSTOMER'S REMEDIES

Manufacturer's entire liability and the customer's exclusive remedy shall be, at Manufacturer's option, either (A) return of the price paid or (B) repair or replacement of the product that does not meet Manufacturer's Limited Warranty and which is returned to Manufacturer within the above time limitations with receipt or other proof of purchase. This Limited Warranty is void if failure of the product has resulted from accident, abuse, misapplication, negligence, or if the product has been damaged, repaired or altered outside of Manufacturer's factory.

NO OTHER WARRANTIES. MANUFACTURER DISCLAIMS ALL OTHER WARRANTIES, EITHER EXPRESSED OR IMPLIED, INCLUDING, BUT NOT LIMITED TO IMPLIED WARRANTIES OF MERCHANTABILITY AND FITNESS FOR A PARTICULAR PURPOSE, WITH RESPECT TO THE PRODUCT AND ANY ACCOMPANYING WRITTEN MATERIALS.

NO LIABILITY FOR CONSEQUENTIAL DAMAGES

In no event shall Manufacturer or its suppliers be liable for any damages whatsoever (including, without limitation, damages for loss of business profits, business interruption, or other pecuniary loss) arising out of the use or inability to use any product of Manufacturer, even if Manufacturer has been advised of the possibility of damages. Because some states do not allow the exclusion or limitation of liability for consequential or incidental damages, the above limitation may not apply to you.

Manufacturer reserves the right to make changes in its products manufactured and/or sold by it at anytime without incurring any obligation to make the same or similar changes in/on products previously manufactured or sold by them.

This Limited Warranty is governed by the laws of the State of Minnesota.

2. TERMS OF PAYMENT

Net 30 days from the date of invoice unless stated otherwise on the invoice. All past due invoices are subject to a 1% monthly finance charge on the outstanding balance.

3. PRICES

We reserve the right to change all prices and terms without notice. The customer shall pay all sales, use, excise, occupational or other similar taxes that might be levied, assessed or otherwise become due.

4. RETURNS

All returns require a "Return Authorization" number (RA). The RA# is available by calling our Customer Service Department at 1-800-367-8657. All authorized returns must be made within 90 days of invoice date.

A 20% net selling price restocking fee will be charged to all items returned after 30 days from the original shipping date.

All product should be returned to Omni-Tract Surgical using the return label on the front of your packing slip. Write your return authorization number in the upper right hand corner.

The following are non-returnable except for manufacturing defects.

1. Sterilized product which has been opened, returned out of the original shipping package or after the expiration date.
2. Engraved product etched by the hospital.
3. Custom made or modified product.
4. Product damaged beyond repair or refurbishing.
5. Obsolete or discontinued product.

MINIMUM ORDERS

Our minimum order is \$30.00.

SHIPPING AND HANDLING

All prices are FOB Destination via ground transportation. Orders requesting next day, 2nd day or 3 day air service will be charged shipping costs.

DAMAGED OR LOST SHIPMENTS

Notify our Customer Service Department immediately. We will advise the carrier of the situation, reshipe your order and place a claim.

Please retain all damaged product and shipping materials for the carrier's inspection.

INSPECTION

Please inspect all items upon arrival. If the order is not complete or does not conform to your purchase request, please notify us immediately. Failure to give such notice within 30 days of delivery will obligate you to accept and pay for all items in accordance with our terms.



A Division of Minnesota Scientific, Inc.

U.S. Patent Nos. 4,355,631; 4,617,916; 4,718,151;
4,930,932; 4,949,707; 5,020,195; 5,242,240;
5,380,338; 5,400,772; 5,688,223; 5,727,899;
5,792,046; 5,882,298; 5,899,627; 6,264,396;
6,315,718; D343,235; Other Patents Pending

4849 White Bear Parkway, St. Paul, MN 55110 USA
800-367-8657 • 651-287-4300 • fax: 651-287-4400

www.omni-tract.com

©2003 Omni-Tract Surgical 2/03 40-6115



OMNI-TRACT, AdvanceTract, Arthro-Tract, FastSystem,
Omni-Clamp, Omni-Ring, Omni-LapoTract, Lapo-Clamp,
Spine-Tract, Wishbone and SnapClamp are registered
trademarks of Minnesota Scientific, Inc.